

BORAS 110

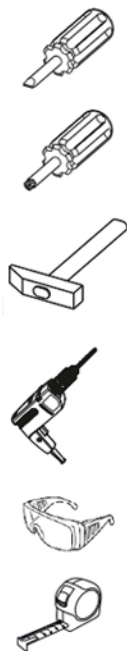

A1 7x34 28	A2 Ø15x12 28
N1 8	S5 Ø18 20
C1 8x35 40	

No	L, mm	B, mm	H, mm	Q	No pack
1	1100	600	22	1	1/1
2	1058	560	16	1	1/1
3	478	84	18	2	1/1
4	478	84	18	2	1/1
5	478	84	18	2	1/1
6	478	84	18	2	1/1
7	928	84	16	2	1/1
8	392	84	16	2	1/1

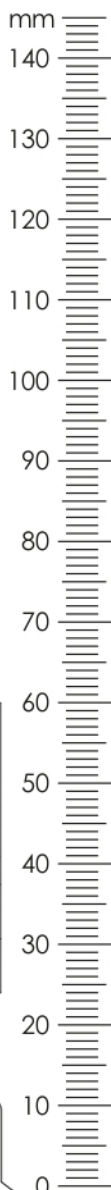
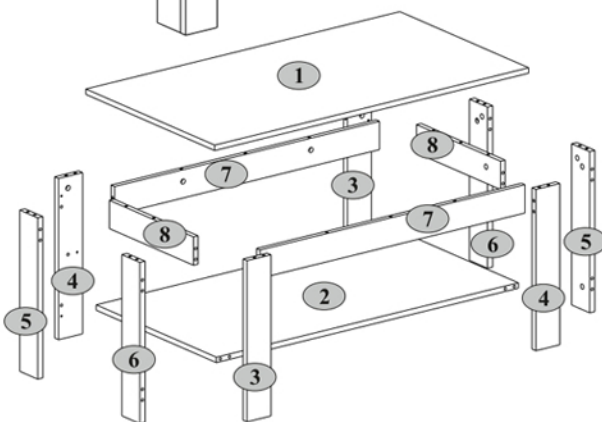
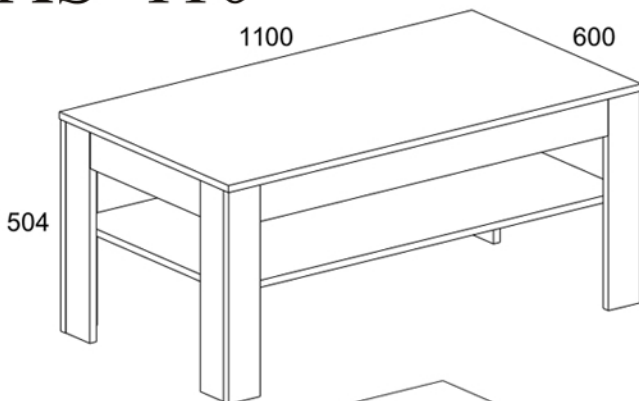
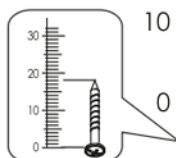
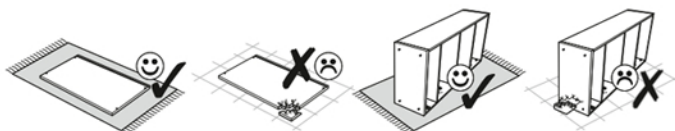

1

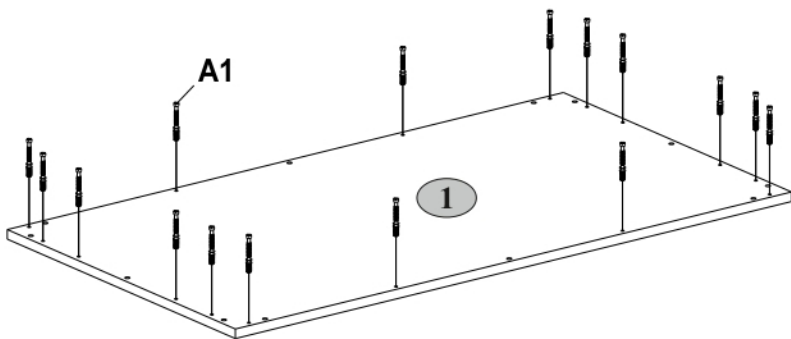
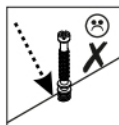
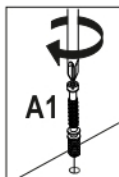
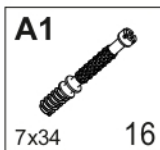

2

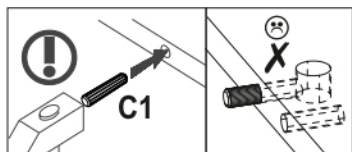
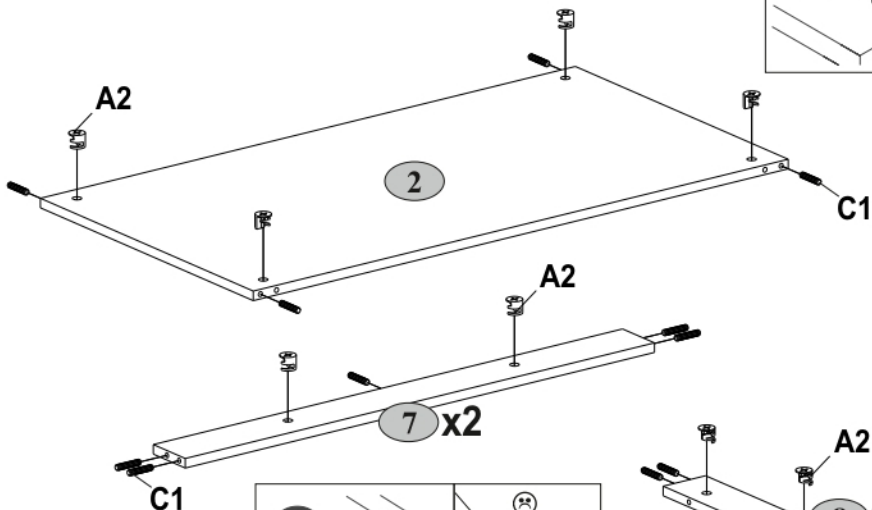
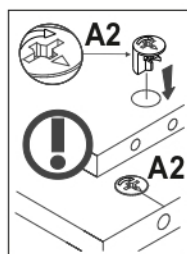
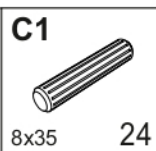
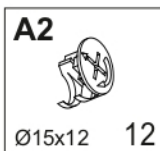

3

x2

A1

7x34

A2

12

Ø15x12

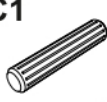
C1

16

8x35

16

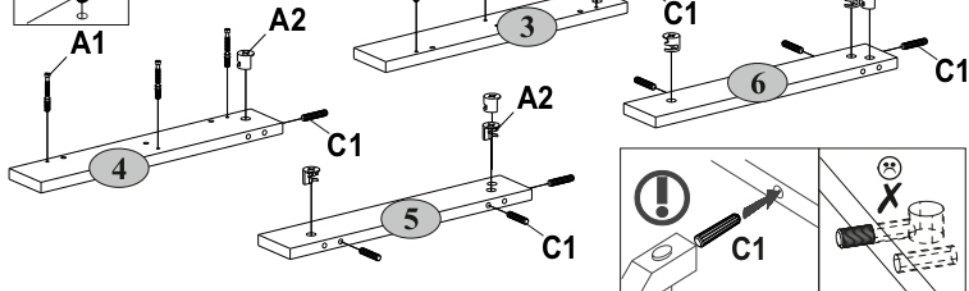
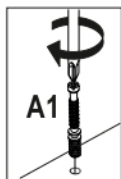
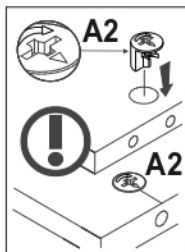
**4**

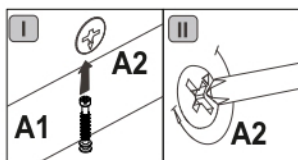
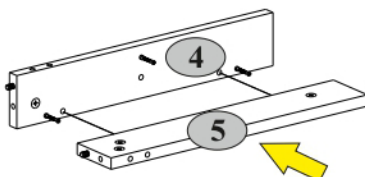
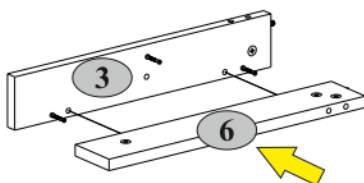

x2

**5**

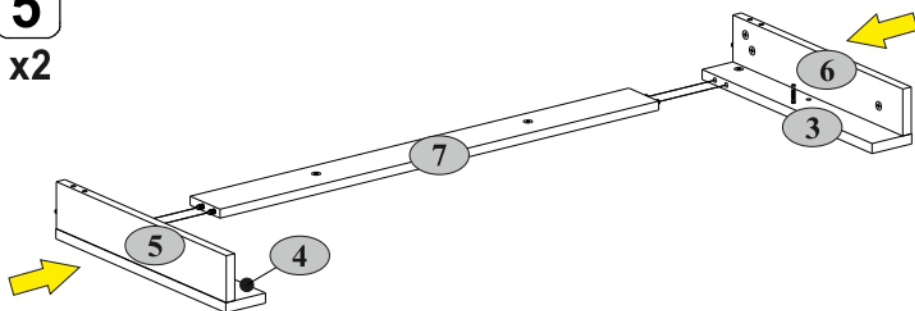
x2

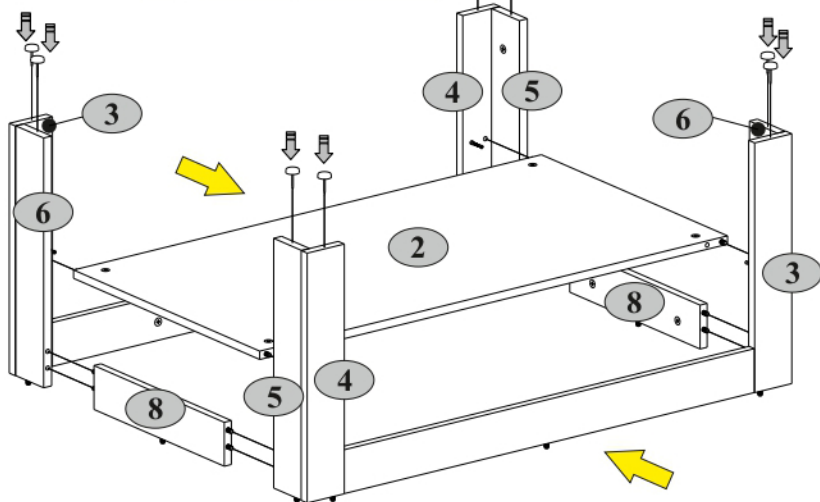
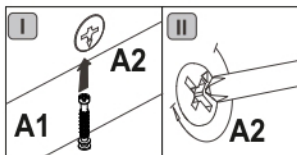
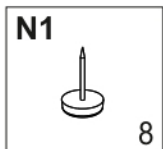
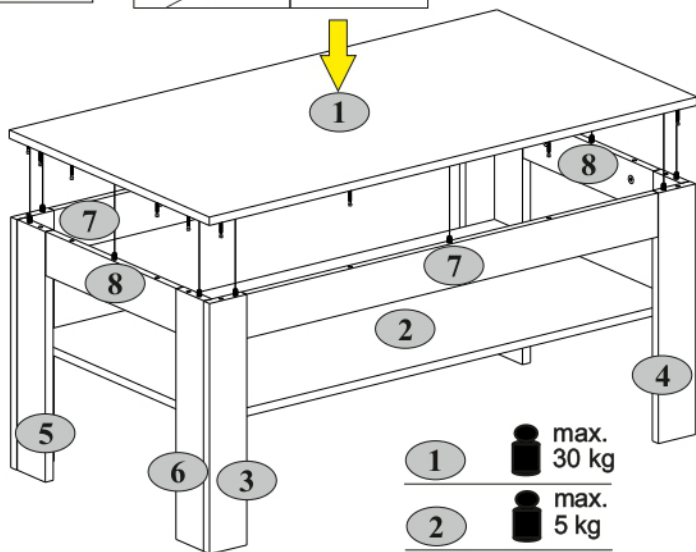
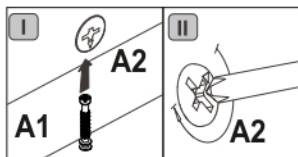
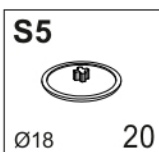

6**7**

- | | | |
|---|---|---------------|
| 1 |  | max.
30 kg |
| 2 |  | max.
5 kg |